

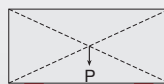

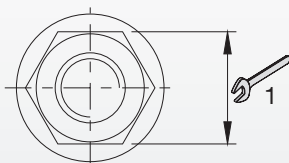
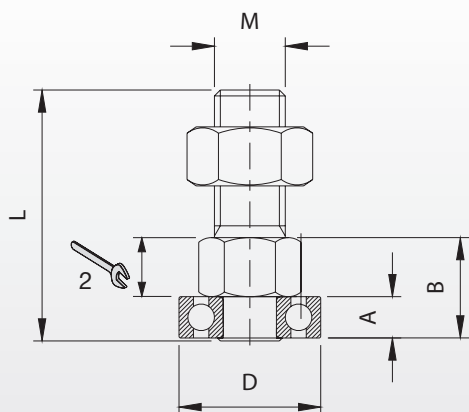

Perno con cuscinetto

Pivot with bearing
Pivot avec roulement
Bolzen mit Kugellager

244



Peso uniformemente distribuito - Equally distributed weight

Articolo	Codice	A	B	D	L	M				
244-25	11303505 001	7	19	Ø24	41	M12	19	15	20	1,30
244-30	11303510 001	9	22	Ø30	45	M14	22	17	20	2,10
244-40	11303515 001	12	24	Ø40	48	M14	22	19	20	3,20



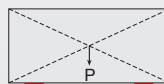
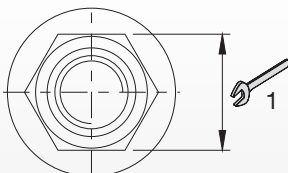
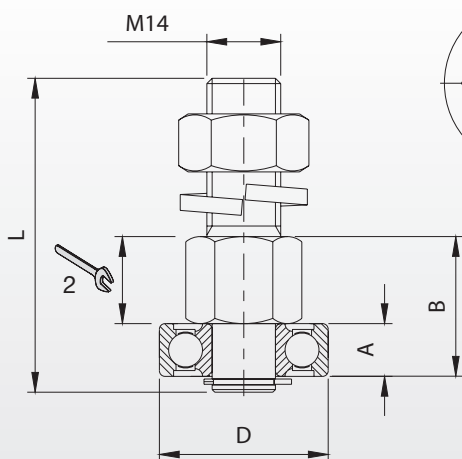

Perno con cuscinetto

Pivot with bearing
Pivot avec roulement
Bolzen mit Kugellager

245



Peso uniformemente distribuito - Equally distributed weight

Articolo	Codice	A	B	D	L				
245-32	11304005 001	10	30	Ø32	60	22	19	20	2,90
245-35	11304010 001	11	30	Ø35	61	22	19	20	3,30
245-42	11304015 001	13	33	Ø42	63	22	19	20	4,10